



# **3GHD-CHO-2x4/2x3**

Multi Rate 3GHD-SDI Distribution Amplifier  
with change-over

## **User manual**

Rev. E

A large, thick green ring or partial circle graphic located in the bottom right corner of the page.

**Nevion**  
Nordre Kullerød 1  
3241 Sandefjord  
Norway  
Tel: +47 33 48 99 99  
[nevion.com](http://nevion.com)

## Nevion Support

Nevion Europe

P.O. Box 1020  
3204 Sandefjord, Norway  
Support phone 1: +47 33 48 99 97  
Support phone 2: +47 90 60 99 99

Nevion USA

1600 Emerson Avenue  
Oxnard, CA 93033, USA  
Toll free North America: (866) 515-0811  
Outside North America: +1 (805) 247-8560

E-mail: [support@nevision.com](mailto:support@nevision.com)

See <http://www.nevision.com/support/> for service hours for customer support globally.

### Revision history

Current revision of this document is the uppermost in the table below.

Rev.	Repl.	Date	Sign	Change description
E	D	2016-04-14	OEH	Extra variant, 3GHD-CHO-2x3-PB-LG
D	C	2015-06-22	AJM	VSTD not supported. LNUM only on hardware 1.1 or newer.
C	2	2014-06-02	OEH MMI	Added setting where output 2 does opposite of cho Updated cover page and removed Declaration of Conformity.
2	1	2012-11-19	RB	Updated table 3 - Description of GPI interface: <ul style="list-style-type: none"> <li>- GPI "Main/Backup" renamed to "Main", and it senses main and not selected input.</li> <li>- Changed to focus on outputs rather than inputs for signal present.</li> </ul> Specifications for electrical outputs: <ul style="list-style-type: none"> <li>- Added note regarding output signal level when using passive bypass versions.</li> </ul> Specifications for electrical inputs: <ul style="list-style-type: none"> <li>- Divided the cable equalization @2970Mbps into 2 classes; with and without relays for passive bypass.</li> </ul> Product overview: <ul style="list-style-type: none"> <li>- Added comment of 60 meters of cable equalizing for 2970Mbps with the passive bypass versions.</li> </ul>
1	0	2011-09-15	MR/AJM	Changed description of VSTD to not be supported on 3G. Added Multicon Gyda status and configuration.
0	-	2011-01-31	MR	Initial revision

# Contents

- Revision history ..... 2
- 1 Product overview ..... 4
- 2 Variants ..... 5
- 3 Specifications ..... 6
- 4 Status by LED's ..... 7
- 5 Status and control from GPI ..... 8
- 6 Configuration by DIP..... 10
  - 6.1 Configuration Examples..... 11
- 7 Status from Multicon Gyda ..... 12
  - 7.1 Label and picture ..... 12
  - 7.2 Input ..... 12
  - 7.3 GPI..... 12
  - 7.4 Voltage ..... 12
  - 7.5 Reclocker ..... 13
  - 7.6 Video analyzer..... 13
  - 7.7 Alarms ..... 13
- 8 Configuration from Multicon Gyda ..... 14
  - 8.1 Card label..... 14
  - 8.2 Firmware upgrade ..... 14
  - 8.3 Electrical input ..... 14
  - 8.4 Reclocker ..... 14
  - 8.5 Electrical output..... 14
  - 8.6 Change over block..... 15
  - 8.7 Output 2 behaviour when set to CHO ..... 16
  - 8.8 Video triggers ..... 17
  - 8.9 Video analyzers ..... 18
- 9 Alarms on Multicon Gyda..... 20
  - 9.1 Electrical input ..... 20
  - 9.2 Reclocker ..... 20
  - 9.3 Change over..... 20
  - 9.4 GPI ..... 20
  - 9.5 Voltage ..... 20
- 10 Information from Multicon Gyda..... 21
- 11 Backplane ..... 22
- General environmental requirements for Nevision equipment..... 24
- Product Warranty..... 25
- Appendix A Materials declaration and recycling information..... 26
  - A.1 Materials declaration ..... 26
  - A.2 Recycling information ..... 26

# 1 Product overview

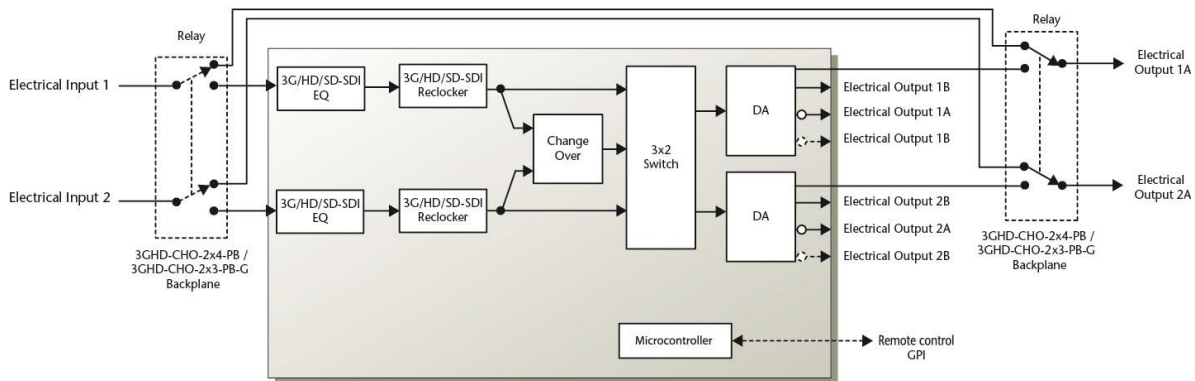

The Flashlink 3GHD-CHO-2x4 is a multi bit-rate distribution amplifier module providing high performance media distribution for various signal formats from 19.4Mbps up to 2970Mbps. The unit can be configured to do cable equalizing and reclocking of SMPTE 424M, SMPTE 292M and SMPTE 259M signal formats.

The two inputs typically provide automatic cable equalizing for up to 70 meters (60 meters for the passive bypass versions) of cable (Belden 1694A at 2970Mbps) with a total of 8/6 reclocked outputs. The 3GHD-CHO-2x4 will detect 3GHD, HD and SD rates and automatically switch to the correct output slew-rate.

The reclockers support the bit-rates 270Mbps, 1483.5Mbps, 1485Mbps 2967Mbps and 2970Mbps. For other rates, the reclockers automatically switch to bypass mode, and the 3GHD-CHO-2x4 will work as a non-reclocking distribution amplifier with cable equalizers.

The 3GHD-CHO-2x4 also supports reclocking of DVB-ASI at 270Mbps, enabling all possible rates including empty transport streams with only K28.5 padding packets. 4 of the outputs are non-inverting and suitable for DVB-ASI.

The unit can be configured as a 1 x 8/6 distribution amplifier including any of the input ports.

The included intelligent change-over feature gives the ability to change input based on input signal loss, loss of lock, EDH errors or a combination of the above.

There is also included a passive bypass function (with backplane board C2 and C4) from both inputs to non-inverted outputs with less than 15 m loss of cable length (enables full redundancy in case of mains failure).

The 3GHD-CHO-2x4 is designed for all distribution purposes in studio, duplication and broadcast applications.

## 2 Variants

The 3GHD-CHO-2x4 main board can be combined with 4 different backplane boards giving functions as follows:

<b>Product</b>	<b>Type of backplane board</b>	<b># Outputs</b>	<b>GPI I/O</b>	<b>Relay (passive loop-through)</b>
19425 3GHD-CHO-2x4	Version C1	8	No	No
19427 3GHD-CHO-2x4-PB	Version C2	8	No	Yes
19429 3GHD-CHO-2x3-G	Version C3	6	Yes	No
19431 3GHD-CHO-2x3-PB-G	Version C4	6	Yes	Yes
24133 3GHD-CHO-2x3-PB-LG	Version C4	6	Legacy	Yes

**Table 1. Product overview.**

Please observe that –G/-LG versions cannot be used with N-Box, Flashlink one module desktop box, due to mechanical issues.

### 3 Specifications

#### Electrical Outputs

Connectors	75 Ohm BNC
Output Return loss	- < -15dB, 5MHz -1.5GHz - < -10dB, 1.5GHz - 3GHz
Output signal level	800mV +/- 10% Note: for the passive bypass versions (using backplane C2 or C4) the signal is attenuated with a cable equivalent of 15m.
Output signal rise / fall time 20% - 80%	- SD limit: [0.4ns – 1.5ns]; <0.5ns rise/fall var. - HD limit: < 270ps, <100ps rise/fall var. - 3G HD limit: <135ps, <50ps rise/fall var.
Amplitude overshoot	<10%
Polarity	- Output O1A, O1B, O2A and O2B: Non inverting electrical - Remaining outputs: inverting electrical
Output timing jitter	- SD: <0.2 UI - HD: <1 UI - 3G HD: <1UI
Output alignment jitter	- SD: <0.15 UI - HD: <0.15 UI - 3G HD: <0.2UI

#### Electrical Inputs

Connectors	75 Ohm BNC
Input Cable Eq. @270Mbps	>300m w/Belden 1694A, with BER < 10E-12
Input Cable Eq. @1485Mbps	>100m w/Belden 1694A, with BER < 10E-12
Input Cable Eq. @2970Mbps	Ver. C1 and C3: >70m w/Belden 1694A, with BER < 10E-12 Ver. C2 and C4: >60m w/Belden 1694A, with BER < 10E-12
Input Return loss	- < -15dB, 5MHz -1.5GHz - < -10dB, 1.5GHz - 3GHz
Jitter tolerance	- SD limit: - 10Hz-1kHz: >1 UI - 10kHz – 5MHz: >0.2 UI - HD limit: - 10Hz-100kHz: >1 UI - 100kHz–10MHz: >0.2 UI - 3G HD limit: - 10Hz-100kHz: >2 UI - 100kHz–10MHz: >0.3 UI

#### Features

Reclocking:	Automatic SD/ HD detection Automatic output slew rate adjustment according to SMPTE 259M and SMPTE 292M/ SMPTE 424M
Supported clock rates:	270, 1483.5, 1485, 2967, 2970Mbps
Input equalizers:	Eq. bypass for non-video formats or low bit rates

#### Supported standards

SMPTE:	SMPTE 424M, SMPTE 292M, SMPTE 259M, SMPTE 305M, SMPTE 310M
DVB-ASI:	EN50083-9 (on non-inverting outputs)

#### General

DC power consumption:	+5V / < 4.5W
-----------------------	--------------

## 4 Status by LED's

The status of the module can be easily monitored visually by the LEDs at the front of the module. The LEDs are visible through the front panel as shown below.

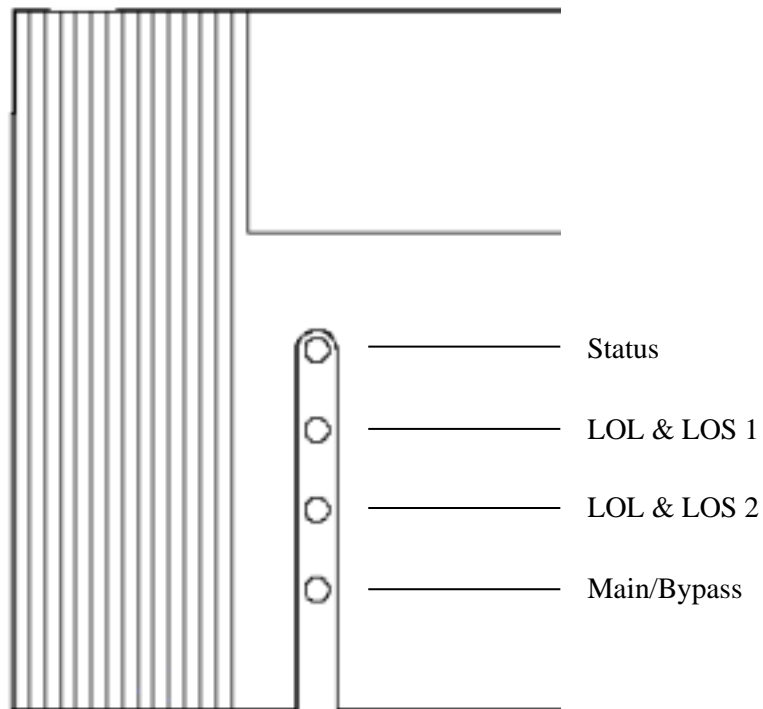

Figure 1 - Panel indicator overview (Text not printed on the front panel)

The functions of the different LEDs are described in table below.

Diode \ state	Red LED	Yellow LED	Green LED	No light
Status	Module is faulty		Module is OK Module has power	Module has no power
LOL & LOS 1 (Input 1)	No Reclocker Lock & Loss Of Signal	No Reclocker lock & Signal present	Reclocker in lock & Signal present	
LOL & LOS 2 (Input 2)	No Reclocker Lock & Loss Of Signal	No Reclocker lock & Signal present	Reclocker in lock & Signal present	
Main/Bypass	No stable input	Bypass selected	Main selected	

Table 2. LED status description

## 5 Status and control from GPI

### 5.1 3GHD-CHO-2x3-G and 3GHD-CHO-2x3-PB-G

On the backplane there is a GPI port. This connector can be used for monitoring the modules status. Also the change over function can be controlled through this connector.

GPI name (setup1/ setup2)	Function (setup1/ setup2)	Pin #	Mode	Direction	Electrical Maximums for GPI outputs:
Status	General error status for the module	Pin 1	Inverted Open Collector (open is alarm)	Output	Max current: 100mA Max voltage: 30V Max power: 200mW
Main	Loss of signal or lock at main input	Pin 2	Inverted Open Collector (open is alarm)	Output	
Signal present 1	Good signal routed to output 1	Pin 3	Inverted Open Collector (open is alarm)	Output	
Signal present 2	Good signal routed to output 2	Pin 4	Inverted Open Collector (open is alarm)	Output	
Reset	Reset selected input to main	Pin 5	TTL, 0V = active level	Input	
Set	Set selected input to standby	Pin 6	TTL, 0V = active level	Input	
	Not used	Pin 7			
Ground	0 volt pin	Pin 8	0V.		

Table 3 - Description of GPI interface

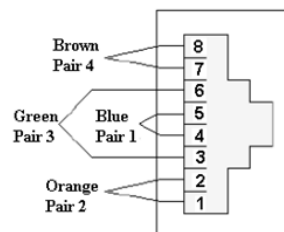

Figure 2 - GPI interface



## 5.2 3GHD-CHO-2x3-PB-LG

On the backplane there is a GPI port. This connector can be used for monitoring the modules status. Also the change over function can be controlled through this connector. On this variant, the GPI functions have been designed to be compatible with the older HDSDI-CHO-2x1 module. Note that the function of pin 3 and 4 are only dependent on the automatic selection done by the change-over block, not the manual routing done in the output matrix. See block diagram on page 4. If both outputs are routed to the change-over block, this effectively makes 3GHD-CHO-2x3-PB-LG function like HDSDI-CHO-2x1-PB.

GPI name (setup1/ setup2)	Function (setup1/ setup2)	Pin #	Mode	Direction	Electrical Maximums for GPI outputs:
Status	General error status for the module	Pin 1	Inverted Open Collector (open is alarm)	Output	Max current: 100mA Max voltage: 30V Max power: 200mW
LOS	Loss of signal or lock at main input	Pin 2	Inverted Open Collector (open is alarm)	Output	
Input 1	Input 1 selected by CHO	Pin 3	Inverted Open Collector (open is alarm)	Output	
Input 2	Input 2 selected by CHO	Pin 4	Inverted Open Collector (open is alarm)	Output	
Reset	Reset selected input to main	Pin 5	TTL, 0V = active level	Input	
Set	Set selected input to standby	Pin 6	TTL, 0V = active level	Input	
	Not used	Pin 7			
Ground	0 volt pin	Pin 8	0V.		

Table 4 - Description of GPI interface

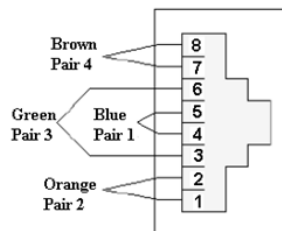
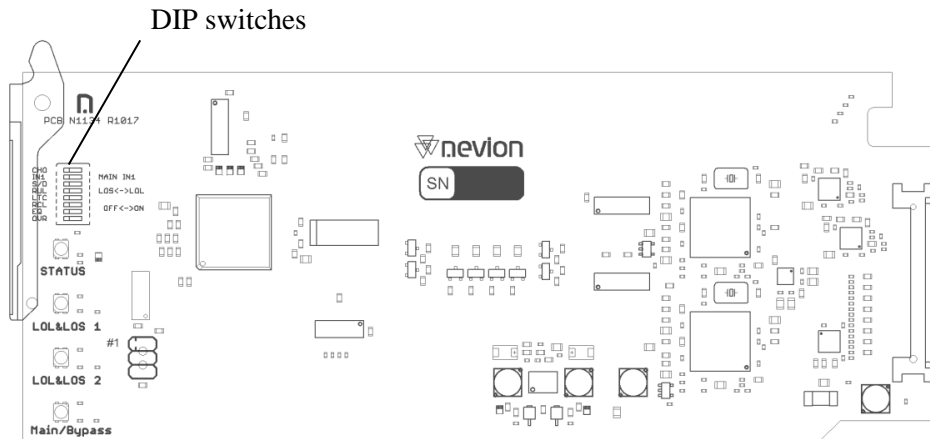

Figure 3 - GPI interface

## 6 Configuration by DIP

The 3GHD-CHO-2x4 supports a number of different formats. The correct configuration can either be set with a DIP switch or with the GYDA system controller. The layout of 3GHD-CHO-2x4 is shown in the drawing below.



**Figure 4. 3GHD-CHO-2x4 module layout**

DIP switch configuration must be set according to the table below:

Switch #	Label	Function DIP=OFF	Function DIP=ON	Comment
1	CHO	Distribution functionality	Change-over functionality	Card functionality
2	IN1	Input 1 standby, 2 main	Input 1 main, 2 standby	Select main/standby for CHO and DA
3	S/D	Single 1x8 (1x6 with GPI) from main	Dual 1x4 (1x3 with GPI)	With CHO, dual mode gives CHO + distributed standby signal
4	RUL	Loss of signal	Loss of lock	Signal integrity decision in change-over mode. N/A in distribution mode.
5	LTC	Non-latching switch. Will automatically return to main when input signal is "good"	Latching switch. Must be reset to return from standby to main	"Sticky" switching "good" is depending on switch criteria in change-over mode. N/A in distribution mode.
6	RCL	Reclocker Bypass	Reclocker ON	Reclocker mode
7	EQ	Cable equalizer Bypass (Loss of signal will not work on this mode)	Cable Equalizer ON	Equalizer mode
8	OVR	Module controlled by Gyda system controller	Module controlled by DIP switches	Select GYDA config. mode

**Table 5: 3GHD-CHO DIP switches**

All DIP switches are off when pointing towards the release handle.

## 6.1 Configuration Examples

Typical configurations for 3GHD-CHO-2x4:

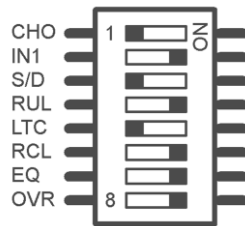

**Figure 5. Distribution mode, Input 1 priority, Input 1 to all outputs, reclocker and equalizer on.**

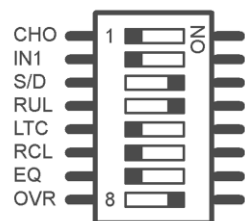

**Figure 6. Distribution mode, Input 2 priority, Input 1 to 4 outputs, Input 2 to 4 outputs, transparent mode without equalization and reclocking.**

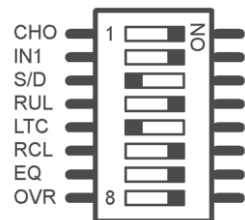
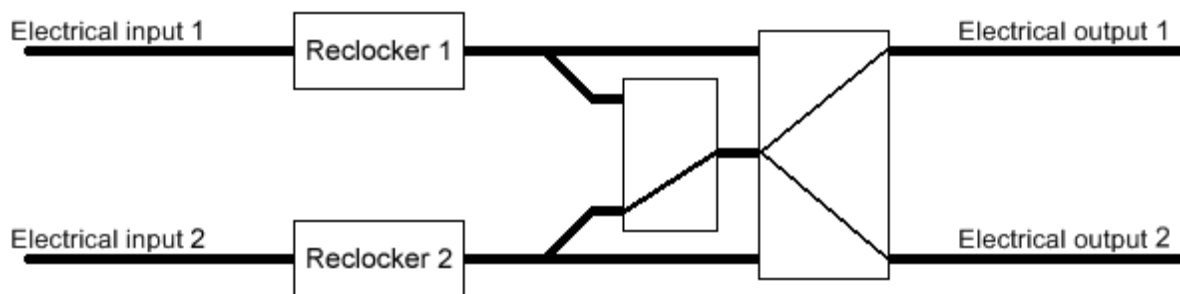

**Figure 7. Change-over mode, input 1 priority, single distributed output, loss of lock criteria, non latching switch, reclocker and equalizer on**

## 7 Status from Multicon Gyda

### 7.1 Label and picture

#### 3GHD Dist amp and change over



The module label is shown above the picture. The picture is changing depending on the status of the module. All alarms are shown with red crosses. The output selection and the main input on the change over block are shown by changing the lines inside the switch block.

### 7.2 Input

Electrical input 1	Normal	Signal detected
Electrical input 2	Normal	Signal detected

Input signal status is shown together with the configuration of the inputs; bypass, mute or normal.

### 7.3 GPI

GPI "Reset"	Inactive
GPI "Set"	Inactive

Show the status of the input pin on the GPI connector on the backplane. Inactive means no signal while Active means signal.

### 7.4 Voltage

Voltage (5.0V)	5.30 V
Voltage (3.3V)	3.32 V
Voltage (1.2V)	1.20 V

Shows the actual voltages on the module together with the nominal voltages.

### 7.5 Reclocker

Reclocker 1	Locked	2970 Mbps	HD
Reclocker 2	Locked	1485 Mbps	HD

Shows the status of the reclocker together with the formats and bitrates.

### 7.6 Video analyzer

Channel 1	1080/25i		Error counter: 0				Reset
			NO_EDH	VS	FF-CRC	AP-CRC	LOCK
	CCS	YCS	CCRC	YCRC	LNUM	SAV	EAV
Channel 1, 2nd stream (level B)	1080/25i		Error counter: 0				Reset
							LOCK
	CCS	YCS	CCRC	YCRC	LNUM	SAV	EAV
Channel 2	1080/25i		Error counter: 0				Reset
			NO_EDH	VS	FF-CRC	AP-CRC	LOCK
	CCS	YCS	CCRC	YCRC	LNUM	SAV	EAV
Channel 2, 2nd stream (level B)	Loss of signal		Error counter: 0				Reset
							LOCK
	CCS	YCS	CCRC	YCRC	LNUM	SAV	EAV

Shows the status of the video analyzer for each input together with the level B channel status. Also the video format is shown. The error counter shows the number of errors that has happen according to the video analyzer configuration. The error count can be reset by pressing the reset button. This analyzer do not reset the changeover latch which has to be done by the GPI connector or for the configuration tab.

### 7.7 Alarms

Alarms		
Electrical input 2	ACKNOWLEDGED	
Main Input	ALARM	Acknowledge
Reclocker 1	RESTORED	Acknowledge
Reclocker 2	ALARM	Acknowledge

All active alarms are shown as red and can be acknowledge by pressing the button. The alarms then change color to yellow, meaning all acknowledged alarms is shown in yellow. All restored alarms are shown in green, by acknowledge them they will disappear form the list.

## 8 Configuration from Multicon Gyda

### 8.1 Card label

Card label	<input type="text"/>	Locate Card	<input type="text"/> sec
------------	----------------------	-------------	--------------------------

Assign a name to the Flashlink module, up to 31 characters. When the locate is pushed all indicators/LED's on front of the module will flash for 120 seconds, alternative an period can be enter into the sec box.

### 8.2 Firmware upgrade

Firmware upgrade	Upload file:	None ▼
------------------	--------------	--------

Update the firmware on the Flashlink module. The firmware file first has to be uploaded to Multicon Gyda first by ftp. See user manual on Multicon Gyda for help on uploading.

### 8.3 Electrical input

Electrical input 1	<input checked="" type="radio"/> Normal	<input type="radio"/> Bypass	<input type="radio"/> Mute
Electrical input 2	<input checked="" type="radio"/> Normal	<input type="radio"/> Bypass	<input type="radio"/> Mute

For SDI signal set the electrical input to normal. For MADI and other low bitrates none SDI signal set this to EQ bypass. Mute will mute the input signal, use this when the input has no signal to prevent noise to appear on the input.

### 8.4 Reclocker

Reclocker 1	<input checked="" type="radio"/> Enable	<input type="radio"/> Bypass	Autobypass: <input type="radio"/> On	<input checked="" type="radio"/> Off
Reclocker 2	<input checked="" type="radio"/> Enable	<input type="radio"/> Bypass	Autobypass: <input type="radio"/> On	<input checked="" type="radio"/> Off

For SDI signal set to enable, else set to bypass. Autobypass only works if the reclocker is enabled. With autobypass on the reclocker will set the reclocker in bypass mode when none SDI signal is detected.

### 8.5 Electrical output

Output selector			
Input:	Electrical input 1	Electrical input 2	Automatic selection
Electrical output 1:	<input type="radio"/>	<input type="radio"/>	<input checked="" type="radio"/>
Electrical output 2:	<input type="radio"/>	<input type="radio"/>	<input checked="" type="radio"/>

Each output can select getting signal from either the two inputs or from the change over block using automatic selection.

## 8.6 Change over block

Main Input	Main: <input type="radio"/> Electrical input 1 <input checked="" type="radio"/> Electrical input 2
	Latch: <input type="radio"/> On <input checked="" type="radio"/> Off <input type="button" value="Reset"/> Hold time: 10 ms Lock time: 10 ms
	Rule: <input checked="" type="radio"/> Los <input type="radio"/> Lol
Allow latch to break on LOS	<input checked="" type="radio"/> Active <input type="radio"/> Inactive

The change over block is called “main input” and all alarms from the change over block are labeled “main input”. \*In the following figure the change over function is explained.

Main Input	Main: <input type="radio"/> Electrical input 1 <input checked="" type="radio"/> Electrical input 2
------------	--

The main input is selected. The other input will automatically be the backup input.

Main Input	Hold time: 10 ms Lock time: 10 ms
	Rule: <input checked="" type="radio"/> Los <input type="radio"/> Lol

In the rules radio button loss of lock or loss of input signal is chosen for the main trigger for doing change over. Addition to this rules and EDH trigger can be setup, see chapter 8.7.

The trigger has an adjustable time control, called "hold time" and “lock time”. This is used for three situations:

1. Multiple bursts of error within timer duration triggers a switching to standby.
2. Single continuous error condition whose duration exceeds timer triggers a switching to standby.
3. Error free periods, whose duration exceeds timer, triggers a switching back to main.

The “hold time” is for main to backup triggering while the “lock time” is for backup to main restoring of the signal.

Main Input	Latch: <input type="radio"/> On <input checked="" type="radio"/> Off <input type="button" value="Reset"/>
Allow latch to break on LOS	<input checked="" type="radio"/> Active <input type="radio"/> Inactive

The latch will select the behavior of the change over. The following block diagram explains the behavior of the change over.

When the latch is set to off:

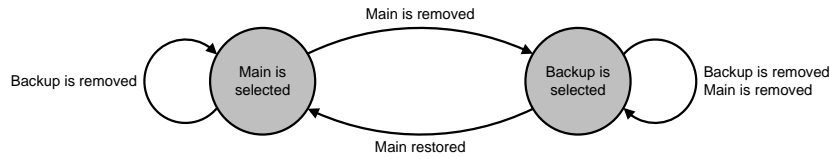

Figure 8

When latch is on and “allow latch to break on los” is inactive:

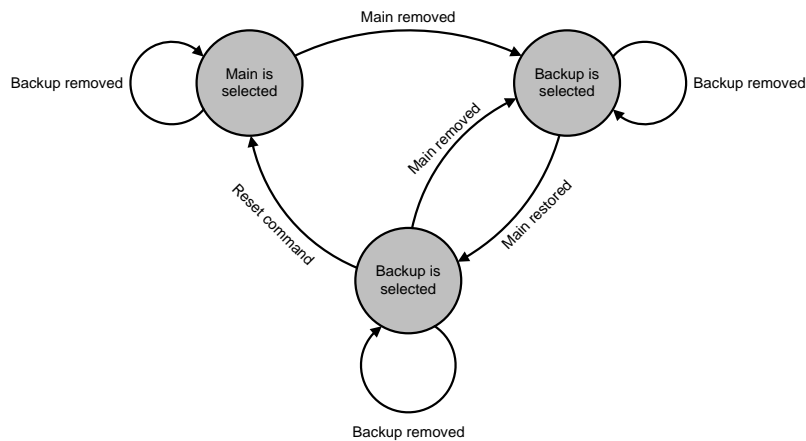

Figure 9

When latch is on and “Allow latch to break on los” is active:

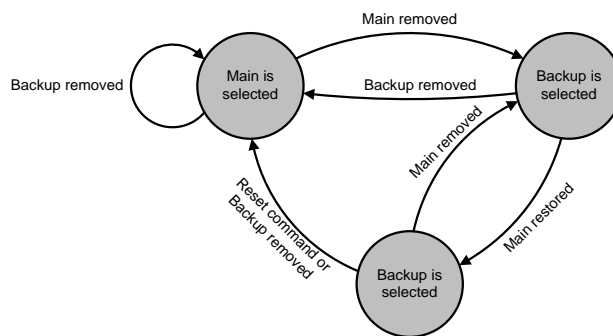

Figure 10

### 8.7 Output 2 behaviour when set to CHO

Output 2 behaviour when set to CHO  Output 2 does opposite of CHO  Output 2 follows CHO

This option was implemented in software version 1.3.146, and can only be enabled/disabled using GYDA/SNMP. When enabled (and output 2 is set to “Automatic selection” according to chapter 8.5), output 2 will do the opposite of the normal automatic selector. This is useful for situations where both inputs should be monitored by external equipment in addition to the internal video monitors.

Gpi 4  Active  Inactive

With Multicon release older than 4.2.0, the option is named GPI 2 (when the module is used with a backplane with no GPI) or GPI 4 (when used with GPI backplane). Active in this instance is to do the opposite of the automatic selection).



### 8.8 Video triggers

A trigger is another way of controlling the change-over functionality than the loss of lock and loss of signal. Each input has their one video trigger, called channel 1 and 2 trigger. In addition also each channel has an A and B analyzer which reflect the level A and B in a 3G-SDI stream. The triggers are using the same information (and therefore have the same bit names as the analyzers), but have separate bit masks. This means that it is possible to count one set of error types, while using a different error type to control the change-over. This video triggers can trigger a change over together with loss of lock or loss of signal. The video trigger can be enabled by selecting the four disable/enable radio buttons

Channel 1 (A) trigger	<input type="radio"/> Enable <input checked="" type="radio"/> Disable		Hold time: 4000 ms							
	Bit operator:						EDH	VSTD	FFCRC	APCRC
	<input type="radio"/> And <input checked="" type="radio"/> Or		LOCK	CCS	YCS	CCRC	YCRC	LNUM	SAV	EAV
			<input checked="" type="checkbox"/>	<input checked="" type="checkbox"/>	<input checked="" type="checkbox"/>	<input checked="" type="checkbox"/>	<input checked="" type="checkbox"/>	<input type="checkbox"/>	<input checked="" type="checkbox"/>	<input checked="" type="checkbox"/>
Channel 1 (B) trigger	<input type="radio"/> Enable <input checked="" type="radio"/> Disable		Hold time: 4000 ms							
	Bit operator:		LOCK	CCS	YCS	CCRC	YCRC	LNUM	SAV	EAV
	<input type="radio"/> And <input checked="" type="radio"/> Or		<input checked="" type="checkbox"/>	<input checked="" type="checkbox"/>	<input checked="" type="checkbox"/>	<input checked="" type="checkbox"/>	<input checked="" type="checkbox"/>	<input type="checkbox"/>	<input checked="" type="checkbox"/>	<input checked="" type="checkbox"/>
			<input checked="" type="checkbox"/>	<input checked="" type="checkbox"/>	<input checked="" type="checkbox"/>	<input checked="" type="checkbox"/>	<input type="checkbox"/>	<input checked="" type="checkbox"/>	<input checked="" type="checkbox"/>	
Channel 2 (A) trigger	<input type="radio"/> Enable <input checked="" type="radio"/> Disable		Hold time: 4000 ms							
	Bit operator:						EDH	VSTD	FFCRC	APCRC
	<input type="radio"/> And <input checked="" type="radio"/> Or		LOCK	CCS	YCS	CCRC	YCRC	LNUM	SAV	EAV
			<input checked="" type="checkbox"/>	<input checked="" type="checkbox"/>	<input checked="" type="checkbox"/>	<input checked="" type="checkbox"/>	<input type="checkbox"/>	<input checked="" type="checkbox"/>	<input checked="" type="checkbox"/>	
Channel 2 (B) trigger	<input type="radio"/> Enable <input checked="" type="radio"/> Disable		Hold time: 4000 ms							
	Bit operator:		LOCK	CCS	YCS	CCRC	YCRC	LNUM	SAV	EAV
	<input type="radio"/> And <input checked="" type="radio"/> Or		<input checked="" type="checkbox"/>	<input checked="" type="checkbox"/>	<input checked="" type="checkbox"/>	<input checked="" type="checkbox"/>	<input checked="" type="checkbox"/>	<input type="checkbox"/>	<input checked="" type="checkbox"/>	<input checked="" type="checkbox"/>
			<input checked="" type="checkbox"/>	<input checked="" type="checkbox"/>	<input checked="" type="checkbox"/>	<input checked="" type="checkbox"/>	<input type="checkbox"/>	<input checked="" type="checkbox"/>	<input checked="" type="checkbox"/>	

There is one trigger for each analyzer, there are triggers for both the main and standby input, an error condition on main input doesn't necessarily mean the change-over will switch, but for simplicity the following description assumes that the standby channel is always "good".

These trigger event is:

EDH	No EDH packets (SD only)
VSTD	SMPTE 352 packets do not correspond to detected video standard (SD/HD only) Not supported.
FFCRC	Full Field CRC (SD only)
APCRC	Active Picture CRC (SD only)
LOCK	Analyzer chip is not locked to a bit stream (or stream 2 not present, for "Stream 2" analyzer)
CCS	Chroma channel ancillary data check sum error
YCS	Luma channel ancillary data check sum error
CCRC	Chroma channel video data check sum error
YCRC	Luma channel video data check sum error
LNUM	Line number error. Only on hardware 1.1 or newer.
SAV	Start of active video flags missing or misplaced
EAV	End of active video flags missing or misplaced

Errors are checked once per video field (LOCK errors are counted every 20ms when no video is present). If an error occurs, it is checked against the bit mask, and if selected for counting increments the error counter. An SNMP tool is recommended for tracking error counts over time, with selectable limits on error rate and max count before generating a warning.

Each trigger has an adjustable time control, called "hold time". This is used for three situations:

1. Multiple bursts of error within timer duration triggers a switching to standby.
2. Single continuous error condition whose duration exceeds timer triggers a switching to standby.
3. Error free periods, whose duration exceeds timer, triggers a switching back to main.

The trigger also has a setting for "bit operator". It is possible to do a logical AND on the bits after applying the mask. Set to AND, all the individual error types that have been enabled must be occurring to count as an error condition. Set to OR, any enabled error type will suffice.

### 8.9 Video analyzers

Channel 1	Error mask	APV	FFV	NO_EDH	VS	FF-CRC	AP-CRC	LOCK	CCS	YCS	CCRC	YCRC	LNUM	SAV	EAV
	Count:			<input checked="" type="radio"/>	<input checked="" type="radio"/>	<input checked="" type="radio"/>	<input checked="" type="radio"/>	<input checked="" type="radio"/>	<input checked="" type="radio"/>	<input checked="" type="radio"/>	<input checked="" type="radio"/>	<input checked="" type="radio"/>	<input checked="" type="radio"/>	<input checked="" type="radio"/>	<input checked="" type="radio"/>
	Ignore:			<input type="radio"/>	<input type="radio"/>	<input type="radio"/>	<input type="radio"/>	<input type="radio"/>	<input type="radio"/>	<input type="radio"/>	<input type="radio"/>	<input type="radio"/>	<input type="radio"/>	<input type="radio"/>	<input type="radio"/>
Channel 1, 2nd stream (level B)	Error mask	APV	FFV	NO_EDH	VS	FF-CRC	AP-CRC	LOCK	CCS	YCS	CCRC	YCRC	LNUM	SAV	EAV
	Count:							<input checked="" type="radio"/>	<input checked="" type="radio"/>	<input checked="" type="radio"/>	<input checked="" type="radio"/>	<input checked="" type="radio"/>	<input checked="" type="radio"/>	<input checked="" type="radio"/>	<input checked="" type="radio"/>
	Ignore:							<input type="radio"/>	<input type="radio"/>	<input type="radio"/>	<input type="radio"/>	<input type="radio"/>	<input type="radio"/>	<input type="radio"/>	<input type="radio"/>
Channel 2	Error mask	APV	FFV	NO_EDH	VS	FF-CRC	AP-CRC	LOCK	CCS	YCS	CCRC	YCRC	LNUM	SAV	EAV
	Count:			<input checked="" type="radio"/>	<input checked="" type="radio"/>	<input checked="" type="radio"/>	<input checked="" type="radio"/>	<input checked="" type="radio"/>	<input checked="" type="radio"/>	<input checked="" type="radio"/>	<input checked="" type="radio"/>	<input checked="" type="radio"/>	<input checked="" type="radio"/>	<input checked="" type="radio"/>	<input checked="" type="radio"/>
	Ignore:			<input type="radio"/>	<input type="radio"/>	<input type="radio"/>	<input type="radio"/>	<input type="radio"/>	<input type="radio"/>	<input type="radio"/>	<input type="radio"/>	<input type="radio"/>	<input type="radio"/>	<input type="radio"/>	<input type="radio"/>
Channel 2, 2nd stream (level B)	Error mask	APV	FFV	NO_EDH	VS	FF-CRC	AP-CRC	LOCK	CCS	YCS	CCRC	YCRC	LNUM	SAV	EAV
	Count:							<input checked="" type="radio"/>	<input checked="" type="radio"/>	<input checked="" type="radio"/>	<input checked="" type="radio"/>	<input checked="" type="radio"/>	<input checked="" type="radio"/>	<input checked="" type="radio"/>	<input checked="" type="radio"/>
	Ignore:							<input type="radio"/>	<input type="radio"/>	<input type="radio"/>	<input type="radio"/>	<input type="radio"/>	<input type="radio"/>	<input type="radio"/>	<input type="radio"/>

The two inputs have their own analyzer, called channel 1 and 2. In addition also each channel has an A and B analyzer which reflect the level A and B in a 3G-SDI stream.

These errors can be counted (or ignored) based on the settings in the configuration view:

EDH	No EDH packets (SD only)
VSTD	SMPTE 352 packets do not correspond to detected video standard (SD/HD only) Not supported for 3G.
FFCRC	Full Field CRC (SD only)
APCRC	Active Picture CRC (SD only)
LOCK	Analyzer chip is not locked to a bit stream (or stream 2 not present, for "Stream 2" analyzer)
CCS	Chroma channel ancillary data check sum error
YCS	Luma channel ancillary data check sum error
CCRC	Chroma channel video data check sum error
YCRC	Luma channel video data check sum error
LNUM	Line number error
SAV	Start of active video flags missing or misplaced
EAV	End of active video flags missing or misplaced

Errors are checked once per video field (LOCK errors are counted every 20ms when no video is present). If an error occurs, it is checked against the bit mask, and if selected for counting increments the error counter. An SNMP tool is recommended for tracking error counts over time, with selectable limits on error rate and max count before generating a warning.



## 9 Alarms on Multicon Gyda

Each alarm can be set to be ignored by the Multicon Gyda alarm handling. Also SNMP trap can be configured to send or ignore alarms. Configure the alarms in Multicon Gyda do not change the behavior of the LED's on the module.

### 9.1 Electrical input

Alarm	Lower limit	Upper limit	Alarm		SNMP trap	
Electrical input 1			<input checked="" type="radio"/> Normal	<input type="radio"/> Ignore	<input type="radio"/> Send	<input checked="" type="radio"/> Ignore
Electrical input 2			<input checked="" type="radio"/> Normal	<input type="radio"/> Ignore	<input type="radio"/> Send	<input checked="" type="radio"/> Ignore

If the electrical input is missing this alarm will be raised

### 9.2 Reclocker

Alarm	Lower limit	Upper limit	Alarm		SNMP trap	
Reclocker 1			<input checked="" type="radio"/> Normal	<input type="radio"/> Ignore	<input type="radio"/> Send	<input checked="" type="radio"/> Ignore
Reclocker 2			<input checked="" type="radio"/> Normal	<input type="radio"/> Ignore	<input type="radio"/> Send	<input checked="" type="radio"/> Ignore

If the reclocker does not lock to the incoming signal an alarm will be raised.

### 9.3 Change over

Main Input			<input checked="" type="radio"/> Normal	<input type="radio"/> Ignore	<input type="radio"/> Send	<input checked="" type="radio"/> Ignore
------------	--	--	---	------------------------------	----------------------------	---

If the changeover has switch to the backup channel this alarm will be raised.

### 9.4 GPI

GPI "Reset"			<input checked="" type="radio"/> Normal	<input type="radio"/> Ignore	<input type="radio"/> Send	<input checked="" type="radio"/> Ignore
GPI "Set"			<input checked="" type="radio"/> Normal	<input type="radio"/> Ignore	<input type="radio"/> Send	<input checked="" type="radio"/> Ignore

If an input signal is present on the GPI input, these alarms will be raised.

### 9.5 Voltage

Voltage (5.0V)	4500 mV	5500 mV	<input checked="" type="radio"/> Normal	<input type="radio"/> Ignore	<input type="radio"/> Send	<input checked="" type="radio"/> Ignore
Voltage (3.3V)	3000 mV	3600 mV	<input checked="" type="radio"/> Normal	<input type="radio"/> Ignore	<input type="radio"/> Send	<input checked="" type="radio"/> Ignore
Voltage (1.2V)	1000 mV	1400 mV	<input checked="" type="radio"/> Normal	<input type="radio"/> Ignore	<input type="radio"/> Send	<input checked="" type="radio"/> Ignore

If the voltages is out of the range, these alarms will be raised.

## 10 Information from Multicon Gyda

Card version	
hw	1.0
lib	1.1.32
serial	1892905120200101
sw	1.3.112

In the configuration tab the version of the hardware and software is shown. Also the cards unique serial number is shown.

# 11 Backplane

The 3GHD-CHO-2xn has four dedicated backplane modules: DA-3G-2x4-C1, - C2, - C3 and - C4. These modules are mounted at the rear of the sub-rack.

The modules are shown in figure 6 to 9.

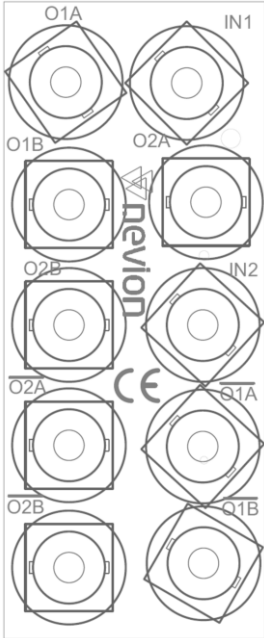

Figure 11. Overview of the DA-3G-2x4-C1 connector module

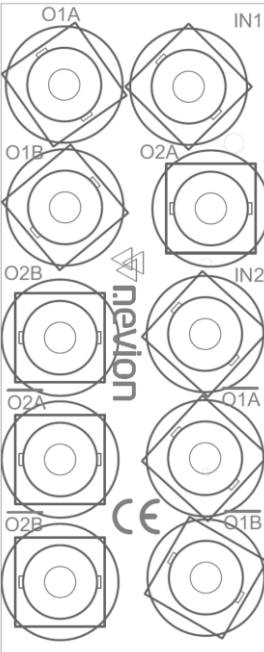
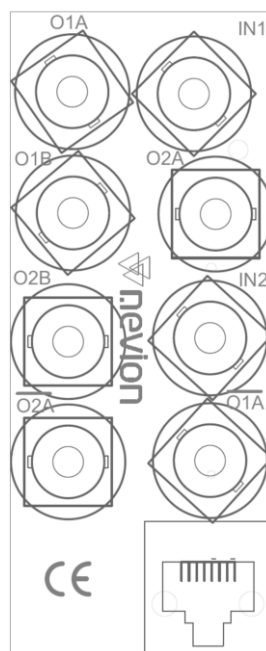

Figure 12. Overview of the DA-3G-2x4-C2 connector module



**Figure 13. Overview of the DA-3G-2x4-C3 connector module**



**Figure 14. Overview of the DA-3G-2x4-C4 connector module**

The electrical input signals are connected to the *IN1* and *IN2* BNCs and the electrical outputs are connected to the *O--* BNCs.

Please note that *O1A*, *O1B*, *O2A* and *O2B* have inverted signals, DVB-ASI cannot be used on these outputs.

Unused inputs and outputs should be terminated with 75 ohm to meet the specifications.

## **General environmental requirements for Nevion equipment**

1. The equipment will meet the guaranteed performance specification under the following environmental conditions:
  - Operating room temperature range: 0°C to 45°C
  - Operating relative humidity range: <90% (non-condensing)
  
2. The equipment will operate without damage under the following environmental conditions:
  - Temperature range: -10°C to 55°C
  - Relative humidity range: <95% (non-condensing)



## **Product Warranty**

The warranty terms and conditions for the product(s) covered by this manual follow the General Sales Conditions by Nevion, which are available on the company web site:

[www.nevion.com](http://www.nevion.com)

## Appendix A Materials declaration and recycling information

### A.1 Materials declaration

For product sold into China after 1st March 2007, we comply with the “Administrative Measure on the Control of Pollution by Electronic Information Products”. In the first stage of this legislation, content of six hazardous materials has to be declared. The table below shows the required information.

組成名稱 Part Name	Toxic or hazardous substances and elements					
	鉛 Lead (Pb)	汞 Mercury (Hg)	鎘 Cadmium (Cd)	六价铬 Hexavalent Chromium (Cr(VI))	多溴联苯 Polybrominated biphenyls (PBB)	多溴二苯醚 Polybrominated diphenyl ethers (PBDE)
3GHD-CHO-2x4 /2x3	○	○	○	○	○	○
<p>O: Indicates that this toxic or hazardous substance contained in all of the homogeneous materials for this part is below the limit requirement in SJ/T11363-2006.</p> <p>X: Indicates that this toxic or hazardous substance contained in at least one of the homogeneous materials used for this part is above the limit requirement in SJ/T11363-2006.</p>						

This is indicated by the product marking:



### A.2 Recycling information

Nevion provides assistance to customers and recyclers through our web site <http://www.nevion.com/>. Please contact Nevion’s Customer Support for assistance with recycling if this site does not show the information you require.

Where it is not possible to return the product to Nevion or its agents for recycling, the following general information may be of assistance:

- Before attempting disassembly, ensure the product is completely disconnected from power and signal connections.
- All major parts are marked or labeled to show their material content.
- Depending on the date of manufacture, this product may contain lead in solder.
- Some circuit boards may contain battery-backed memory devices.