



3GHD-EO-2-SFP

Dual SD/HD/3G-SDI electrical to optical converter
with SFP

User manual

Rev. C

A large, solid green circular graphic with a white circular cutout in the center, located in the bottom right corner of the page.

Nevion
Nordre Kullerød 1
3241 Sandefjord
Norway
Tel: +47 33 48 99 99
neviON.com

Nevion Support

Nevion Europe

P.O. Box 1020
3204 Sandefjord, Norway
Support phone 1: +47 33 48 99 97
Support phone 2: +47 90 60 99 99

Nevion USA

1600 Emerson Avenue
Oxnard, CA 93033, USA
Toll free North America: (866) 515-0811
Outside North America: +1 (805) 247-8560

E-mail: support@nevion.com

See <http://www.nevion.com/support/> for service hours for customer support globally.

Revision history

Current revision of this document is the uppermost in the table below.

Rev.	Repl.	Date	Sign	Change description
C	B	2015-09-29	AD	Corrected optical connector to SC/UPC
B	A	2015-03-26	AD	Connections updated, Figure 13 added.
A	-	2014-10-28	AJM	Initial document

Contents

Revision history	2
1 Product overview	4
2 Specifications	5
2.1 General	5
2.2 Electrical Inputs	5
2.3 Electrical Outputs	5
2.4 Optical Outputs	5
2.5 Standards.....	5
3 Configuration	6
3.1 Multicon Gyda configuration	6
3.2 Configuration through DIP settings.....	7
3.2.1 Cable EQ	9
3.2.2 Re-clocker mode	9
3.2.3 Automatic change over.....	9
3.2.4 Dual converter configuration example	10
3.2.5 Dual converter with changeover configuration example.....	11
4 Operation.....	12
4.1 Module status.....	12
4.1.1 Multicon Gyda status interface	12
5 Connections	13
5.1 Mounting the connector module	13
5.2 Terminal format support	14
5.3 GPI ALARM – Module Status Outputs.....	14
5.3.1 GPI connections.....	14
5.4 Front panel – Status monitoring	16
General environmental requirements for Nevia equipment	17
Product Warranty.....	18
Appendix A Materials declaration and recycling information	19
A.1 Materials declaration.....	19
A.2 Recycling information.....	19

1 Product overview

The Flashlink 3GHD-EO-2-SFP is a dual multi bit-rate electrical to optical converter module providing high performance media conversion for various signal formats from 19.4Mbps up to 2970Mbps. Unmatched signal accuracy, even in critical applications with pathological signal patterns makes the 3GHD-EO-2-SFP the first choice for all optical transport demands.

The 3GHD-EO-2-SFP can transport all SD, HD and 3G signal formats in addition to DVB-ASI and SMPTE310M. It performs optical refreshing and signal re-clocking, which is selectable on application. The optical inputs are embedded in optional SFP module, which makes the module configurable to application specific needs. The open system platform of Nevion Flashlink system allows easy interoperability with third party fiber optical systems.

The 3GHD-EO-2-SFP unit has also two electrical outputs for each converter, which reduces the need for additional DA's.

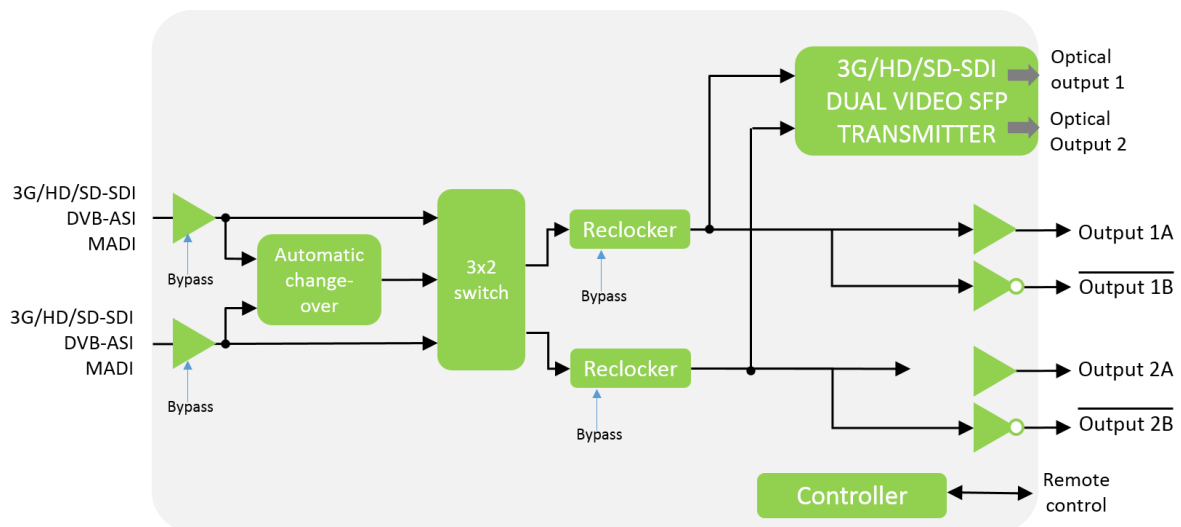

Figure 1 Block diagram of the 3GHD-EO-2-SFP dual converter

2 Specifications

2.1 General

Power	2.5W maximum without SFP 3.5W typical with dual SFP
Control	Control system for access to setup and module status with BITE (Built-In Test Equipment)
Temp. range	0 to +40 °C

2.2 Electrical Inputs

Number of inputs	2
Connector	BNC
Impedance	75 ohm
Return loss	>15dB @ 5-1485MHz >10dB @ 1485-2970MHz
Signal level	Nom. 800mV

2.3 Electrical Outputs

Number of outputs	4 (2 per converter)
Connector	BNC
Impedance	75 ohm
Return loss	>15dB @ 5-1485MHz >10dB @ 1485-2970MHz
Peak to peak signal level	800mV +/- 10%
Signal polarity	1 inverting and 1 non-inverting (per converter)

2.4 Optical Outputs

Number of inputs	2
Transmission circuit fiber	Single mode 9/125um
Connector	SC/UPC, single mode
Optical wavelength	See manual for installed SFP
Optical power	See manual for installed SFP

2.5 Standards

Supported standards for electrical and optical ports:

SMPTE292M, SMPTE259M, SMPTE297M, SMPTE305.2M, SMPTE310M, SMPTE424M, DVB-ASI EN50083-9.

3 Configuration

Configuration of this card can either be done from Multicon Gyda element manager or locally on the card by dipswitches.

3.1 Multicon Gyda configuration

Below is a snapshot from the Multicon Gyda interface.



3GHD SFP dual EO converter with CHO

Card label	<input type="text"/>	Locate card	<input type="text"/>	sec
Firmware upgrade	Upload file:	None	Upload	
Electrical input 1	<input checked="" type="radio"/> Normal <input type="radio"/> Bypass			
Electrical input 2	<input checked="" type="radio"/> Normal <input type="radio"/> Bypass			
Automatic selection	Main: <input checked="" type="radio"/> Electrical input 1 <input type="radio"/> Electrical input 2			
	Latch: <input type="radio"/> On <input checked="" type="radio"/> Off <input type="button" value="Reset"/>			

Output selector			
Input:	Electrical input 1	Electrical input 2	Automatic selection
Optical output 1:	<input type="radio"/>	<input type="radio"/>	<input checked="" type="radio"/>
Optical output 2:	<input type="radio"/>	<input type="radio"/>	<input checked="" type="radio"/>

Reclocker 1	<input checked="" type="radio"/> Enable <input type="radio"/> Bypass	Autobypass: <input type="radio"/> On <input checked="" type="radio"/> Off
Reclocker 2	<input checked="" type="radio"/> Enable <input type="radio"/> Bypass	Autobypass: <input type="radio"/> On <input checked="" type="radio"/> Off
Laser 1	<input type="radio"/> On <input checked="" type="radio"/> Off	
Laser 2	<input type="radio"/> On <input checked="" type="radio"/> Off	
Fibre Breakage detection	<input type="radio"/> Active <input checked="" type="radio"/> Inactive	

Alarm	Lower limit	Upper limit	Alarm	SNMP trap
Electrical input 1			<input checked="" type="radio"/> Normal <input type="radio"/> Ignore	<input type="radio"/> Send <input checked="" type="radio"/> Ignore
Electrical input 2			<input checked="" type="radio"/> Normal <input type="radio"/> Ignore	<input type="radio"/> Send <input checked="" type="radio"/> Ignore
Automatic selection			<input checked="" type="radio"/> Normal <input type="radio"/> Ignore	<input type="radio"/> Send <input checked="" type="radio"/> Ignore
Laser 1			<input checked="" type="radio"/> Normal <input type="radio"/> Ignore	<input type="radio"/> Send <input checked="" type="radio"/> Ignore
Laser 2			<input checked="" type="radio"/> Normal <input type="radio"/> Ignore	<input type="radio"/> Send <input checked="" type="radio"/> Ignore
Voltage (5.0V)	4500 mV	5500 mV	<input checked="" type="radio"/> Normal <input type="radio"/> Ignore	<input type="radio"/> Send <input checked="" type="radio"/> Ignore
Voltage (3.3V)	3000 mV	3600 mV	<input checked="" type="radio"/> Normal <input type="radio"/> Ignore	<input type="radio"/> Send <input checked="" type="radio"/> Ignore
Reclocker 1			<input checked="" type="radio"/> Normal <input type="radio"/> Ignore	<input type="radio"/> Send <input checked="" type="radio"/> Ignore
Reclocker 2			<input checked="" type="radio"/> Normal <input type="radio"/> Ignore	<input type="radio"/> Send <input checked="" type="radio"/> Ignore

Card version	
Serial	rev2208708360200138
hw	1.0
lib	1.2.100
sw	1.0.1

Figure 2 Configuration tab

3.2 Configuration through DIP settings

The 3GHD-EO-2-SFP can support a number of different broadcast formats. The correct configuration can either be set with the two Dipswitches on the card or through the GYDA Control System. The layout is shown in the drawing below with the DIP switches to the upper left position.

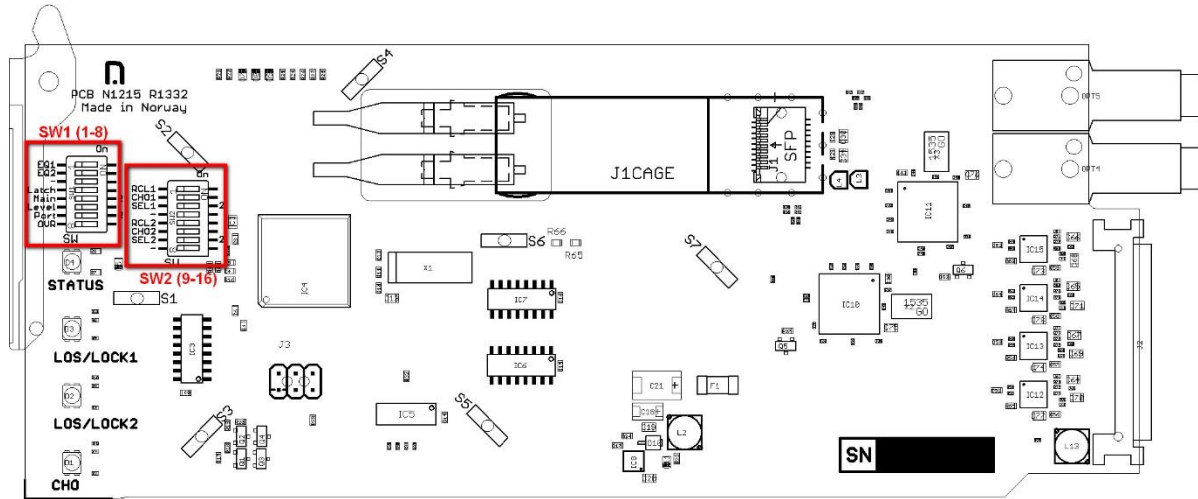

Figure 3 3GHD-EO-2-SFP board layout

Table 1: DIP settings.

Switch #	Label	Function, DIP=OFF	Function, DIP=ON	Comment
1	EQ1	Bypass	Automatic cable Equalizer	Automatic cable Equalizer on electrical input 1
2	EQ2	Bypass	Automatic cable Equalizer	Automatic cable Equalizer on electrical input 2
3				Not used
4	Latch	Non-latching switch. Will automatically return to main when input signal is "good"	Latching switch. Must be reset to return from standby to main	"Sticky" switching "good" is depending on switch criteria in change-over mode.
5	Main	Input 1 is main	Input 2 is main	Select's main input to changeover
6				Not used
7				Not used
8	OVR	GYDA control. Configuration with GYDA	Override GYDA control. Configuration with DIP switch	Select configuration from GYDA
9	RCL1	Reclocker 1 bypass	Reclocker 1 enabled	Sets reclocker mode for output 1
10	CHO1	Change over disabled	Change over enabled	Enables change over for output 1
11	SEL1	Input 1 to output 1	Input 2 to output 2	This setting are overridden if DIP 10 (CHO1) is enabled
12				Not used
13	RCL2	Reclocker 2 bypass	Reclocker 2 enabled	Sets reclocker mode for output 2
14	CHO2	Change over disabled	Change over enabled	Enables change over for output 2
15	SEL2	Input 1 to output 2	Input 2 to output 2	This setting are overridden if DIP 14 (CHO2) is enabled
16				Not used

All DIP switches are off when pointing towards the release handle.

3.2.1 Cable EQ

Electrical input cable eq. can be turned on and off. If SDI signal is used on the input it is advised to set the EQ to on. The input will then adjust for the loss of high frequency component from SDI signal. This will increase the working cable length on the input. If none SDI signal is used on the input, turning of EQ may help increase the cable length if required.

3.2.2 Re-clocker mode

The re-clocker can be set to re-clock or bypass from DIP#9 and DIP#13 or from GYDA.

When re-clocker is set to re-clock mode jitter from signal is removed. Accepted bitrates is 270, 1483.5, 1485, 2967 and 2970Mbps.

When re-clocker is set to bypass the converter accepts all bitrates between 2 to 2970Mbps. Note that in this mode the jitter is not removed and this can cause problems for equipment following the converter.

3.2.2.1 Transparency

This converter only looks at the bitrates and not the content. This means that any signal with correct bitrates is converted. The product is transparent to data in the ancillary space like embedded audio.

3.2.3 Automatic change over

This module has the possibility to have an automatic change over on the input. This can be used in redundancy systems where the user wants automatically switch to a backup port when the main input loses signal. This function can be selected with DIP#10 and Dip#14. The main and backup input can be selected with DIP#5 or from GYDA.

3.2.3.1 Trigger condition and latching

Loss of electrical signal on input trigs the automatic change over. When the main input lose electrical signal the backup input is selected. When the backup input is active an alarm is displayed in GYDA. When the main input electrical signal is restored the converter switches immediately back to main input and alarm is restored if latch is set to off. If latch is set to on the fall back to main input will not happen before the reset is applied to the changeover from the config pan in Multicon Gyda.

Note that bit error or loss of lock on re-clocker does not trigger the automatic change over.

3.2.4 Dual converter configuration example

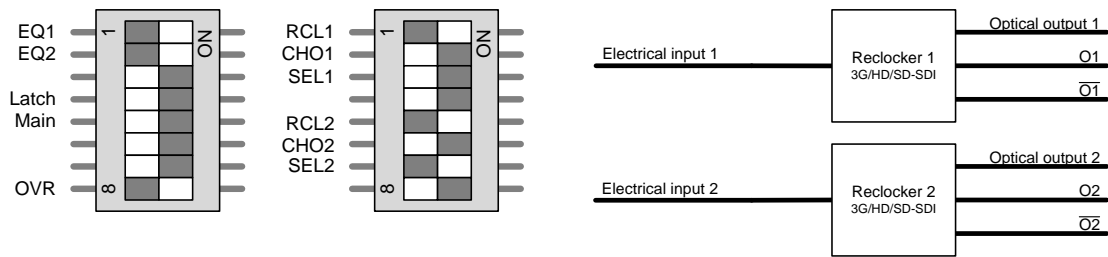

Figure 4 Dual EO converter, standard setup

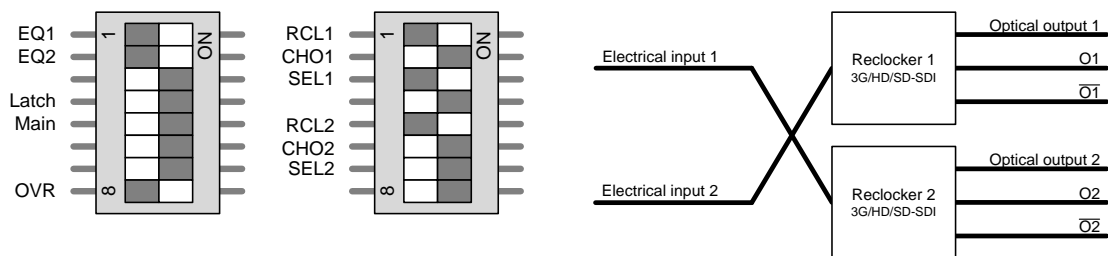

Figure 5 Dual EO converter, input swap

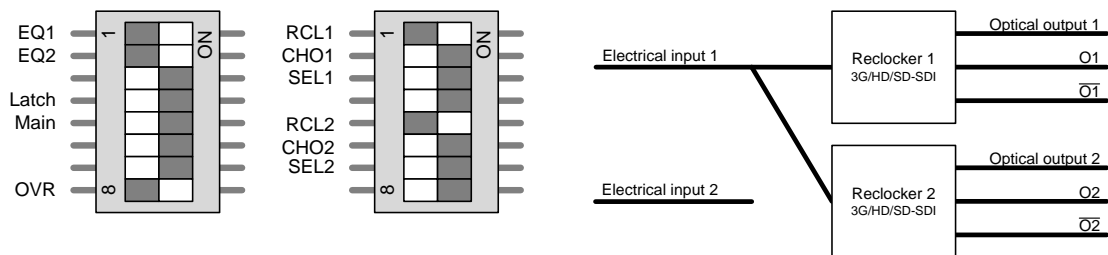

Figure 6 Dual EO converter with DA, input 1

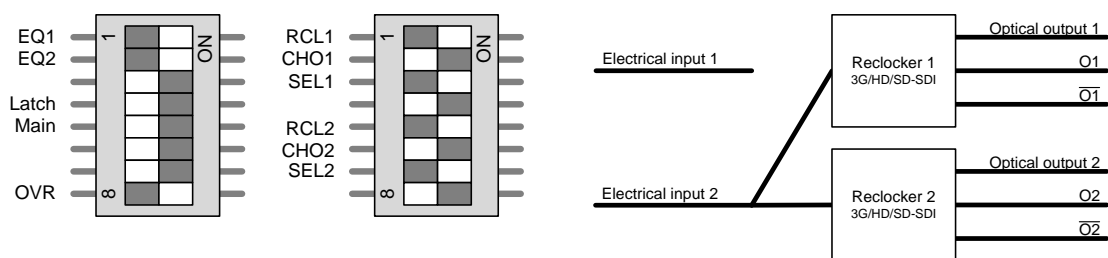

Figure 7 Dual EO converter with DA, input 2

3.2.5 Dual converter with changeover configuration example

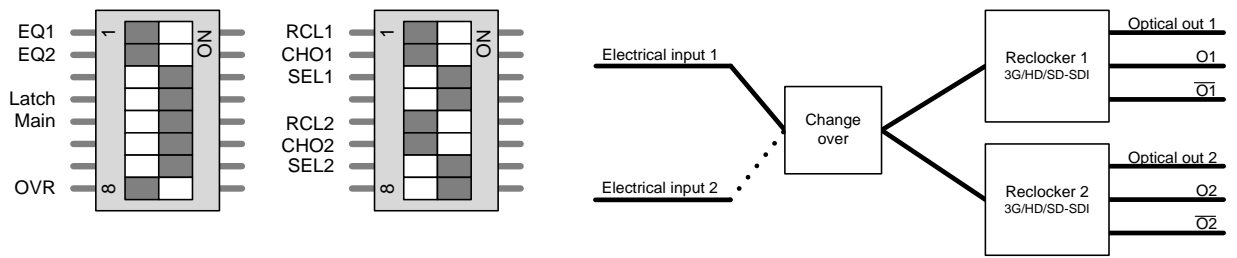

Figure 8 Changeover on all output, optical 1 as main

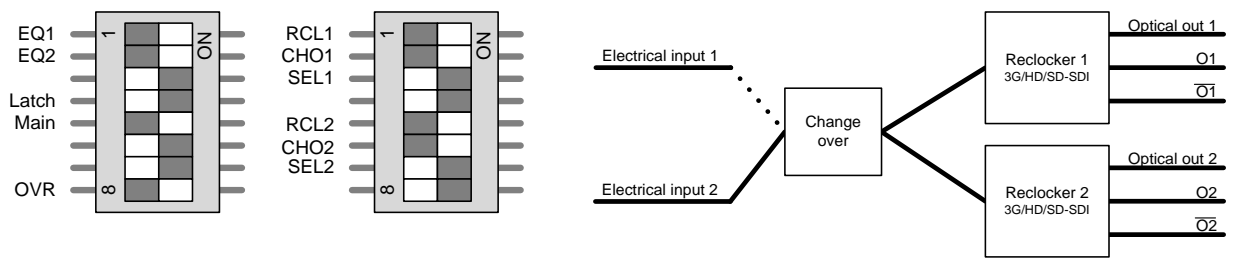

Figure 9 Changeover on all output, optical 2 as main

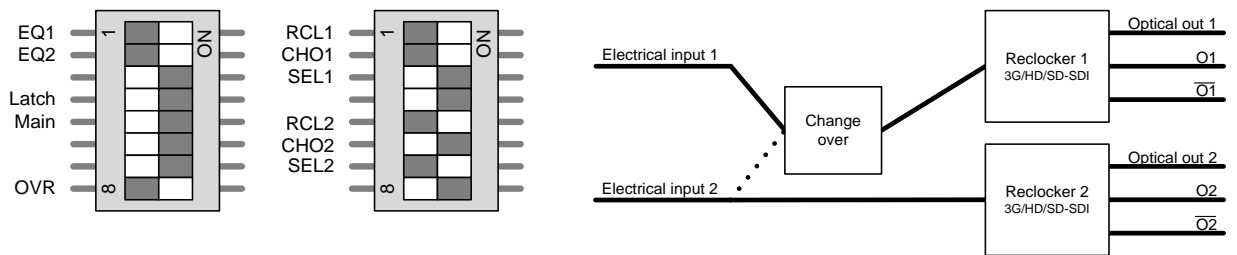

Figure 10 Changeover on output 1, optical 1 as main. Optical 2 on output 2

4 Operation

4.1 Module status

The status of the module can be monitored in three ways.

1. GYDA System Controller (optional).
2. GPI at the rear of the sub-rack.
3. LED's at the front of the sub-rack.

Of these three, the GPI and the LED's are mounted on the module itself, whereas the GYDA System Controller is a separate module giving detailed information on the card status.

4.1.1 Multicon Gyda status interface



3GHD SFP dual EO converter with CHO

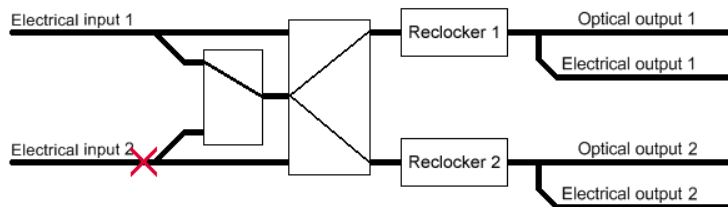

Electrical input 1	Normal	Signal detected	
Electrical input 2	Normal	Loss of signal	
Reclocker 1	Locked	270 Mbps	SD
Reclocker 2	Locked	270 Mbps	SD
Laser 1	On	1310nm	-10.6dBm WDM
Laser 2	On	1310nm	-11.2dBm WDM
SFP Temp	31.7 C		
Voltage (5.0V)	5.06 V		
Voltage (3.3V)	3.33 V		

Alarms		
Electrical input 1	RESTORED	Acknowledge
Electrical input 2	NEW	Acknowledge
Automatic selection	RESTORED	Acknowledge
Reclocker 1	RESTORED	Acknowledge
Reclocker 2	RESTORED	Acknowledge
Card removed	RESTORED	Acknowledge
Acknowledge all. 6 alarms	COMMON	Ack all

Figure 11 Dual converter status tab

The on-board temperature measurement is a feature used for monitoring variations in temperature over time and can be accessed thru SNMP. The absolute value of the temperature measurement has little value of its own as it does not reflect the temperature inside the electronics nor the ambient frame temperature.

5 Connections

The 3GHD-EO-2-SFP has a dedicated connector module; 3GHD-EO-2-C1. This module is mounted at the rear of the sub-rack. The layout of the module is shown in the figure below.

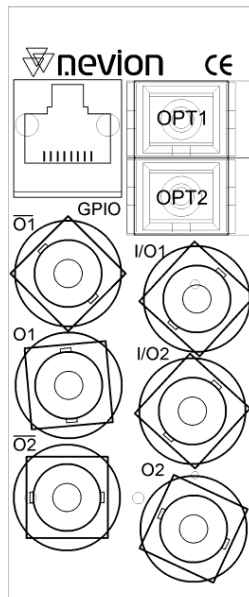

Figure 12 Connector module for 3GHD-EO-L-2-SFP

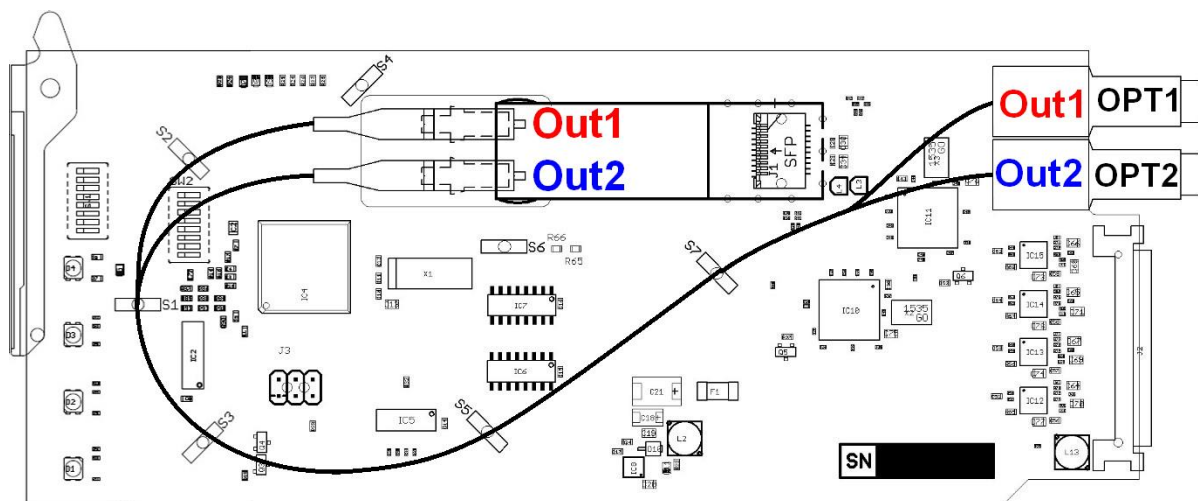

Figure 13: Fiber layout

Out1 as shown in Figure 13 will always have the lowest wavelength when CWDM and DWDM SFP's is installed. So if the SFP installed is a 23033 SFP-3G-EO-2-C1xxx/C1xxx with the wavelengths 1590/1610, Out1 will be 1590 and Out2 will be 1610.

5.1 Mounting the connector module

The details of how the connector module is mounted, is found in the user manual for the sub-rack frame FR-2RU-10-2.

This manual is also available from our web site: <http://www.nevion.com>

5.2 Terminal format support

The different input and output ports on 3GHD-EO-2-SFP can support a number of formats. The table below show which signal formats are supported on the selected terminals.

Unused inputs should be terminated to avoid alarms triggered by noise.

Table 2 Signal support

Terminal	Function	Supported Format	Mode
OPT1 OPT2	Optical output	SDI, DVB-ASI, SMPTE310, Transparent	Output
I/O1 I/O2 O1 O2	Electrical input	SDI, DVB-ASI, Transparent	Input
O1 O2	Electrical Output Reclocked DA output	SDI, DVB-ASI, Transparent	Output
$\overline{O1}$ $\overline{O2}$	Electrical Output Reclocked DA inverted output	SDI, Transparent	Output
GPI ALARM	Open Collector Alarms	Wired alarms	OC Output

5.3 GPI ALARM – Module Status Outputs

These outputs can be used for wiring up alarms for third party control systems. The GPI outputs are open collector outputs, sinking to ground when activated. The GPI connector is shown in figures below.

Electrical maximums for GPI outputs:

Max current: 100mA

Max voltage: 30V

5.3.1 GPI connections

3GHD-EO-SFP module GPI pinning:

Signal	Name	Pin #	Mode
Status	General error status for the module.	Pin 1	Open Collector This is normally closed.
LOS1	Loss of signal on input 1.	Pin 2	Open Collector
LOS2	Loss of signal on input 2. Only for dual converter	Pin 3	Open Collector
Ground	0V / gnd pin.	Pin 8	0V.

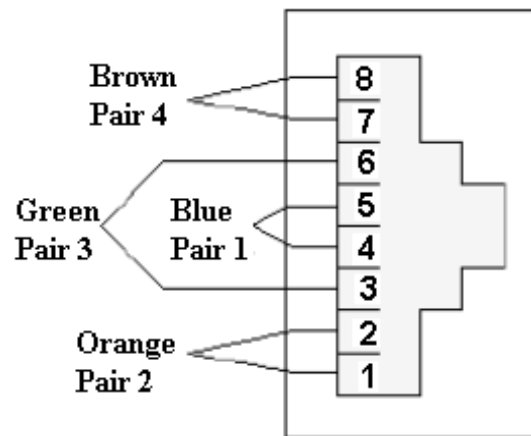

Figure 14 GPI connector

5.4 Front panel – Status monitoring

The status of the module can be easily monitored visually by the LED's at the front of the module. The LED's are visible through the front panel as shown in the figure below.

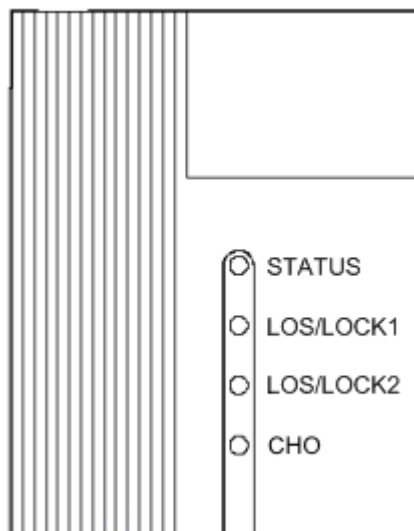

Figure 15 Front panel LED's

The 3GHD-EO-2-SFP has 3 LED's each showing a status corresponding to the GPI pinning. When DIP#3 is on the LED's are used as an optical power meter.

Table 3 Front panel LED's

Diode \ State	Red LED	Yellow LED	Green LED	No light
Status	Module is faulty, or module is initializing.	N/A	Module is OK Module power is OK	Module has no power
LOS/LOCK1	No input signal on electrical output 1.	Input signal on electrical output 1 but reclocker not in lock.	Input signal on electrical output 1 and reclocker in lock.	
LOS/LOCK2	No input signal on electrical output 2.	Input signal on electrical output 1 but reclocker not in lock.	Input signal on electrical output 1 and reclocker in lock.	
CHO	Main input selected on cho	N/A	Backup input assigned to cho	No output signal assigned to the cho block

General environmental requirements for Nevion equipment

1. The equipment will meet the guaranteed performance specification under the following environmental conditions:
 - Operating room temperature range: 0°C to 45°C
 - Operating relative humidity range: <90% (non-condensing)

2. The equipment will operate without damage under the following environmental conditions:
 - Temperature range: -10°C to 55°C
 - Relative humidity range: <95% (non-condensing)

Product Warranty

The warranty terms and conditions for the product(s) covered by this manual follow the General Sales Conditions by Nevion, which are available on the company web site:

www.nevion.com

Appendix A Materials declaration and recycling information

A.1 Materials declaration

For product sold into China after 1st March 2007, we comply with the “Administrative Measure on the Control of Pollution by Electronic Information Products”. In the first stage of this legislation, content of six hazardous materials has to be declared. The table below shows the required information.

組成名稱 Part Name	Toxic or hazardous substances and elements					
	鉛 Lead (Pb)	汞 Mercury (Hg)	鎘 Cadmium (Cd)	六价铬 Hexavalent Chromium (Cr(VI))	多溴联苯 Polybrominated biphenyls (PBB)	多溴二苯醚 Polybrominated diphenyl ethers (PBDE)
3GHD-EO-2-SFP	○	○	○	○	○	○
<p>O: Indicates that this toxic or hazardous substance contained in all of the homogeneous materials for this part is below the limit requirement in SJ/T11363-2006.</p> <p>X: Indicates that this toxic or hazardous substance contained in at least one of the homogeneous materials used for this part is above the limit requirement in SJ/T11363-2006.</p>						

This is indicated by the product marking:



A.2 Recycling information

Nevion provides assistance to customers and recyclers through our web site <http://www.nevion.com/>. Please contact Nevion’s Customer Support for assistance with recycling if this site does not show the information you require.

Where it is not possible to return the product to Nevion or its agents for recycling, the following general information may be of assistance:

- Before attempting disassembly, ensure the product is completely disconnected from power and signal connections.
- All major parts are marked or labeled to show their material content.
- Depending on the date of manufacture, this product may contain lead in solder.
- Some circuit boards may contain battery-backed memory devices.